



D-Line | Tabletop Autoclaves

 Class S & Class N

SUPPLYLAB
GRUPO CERTILAB COMPANY
SOLUTIONS YOU CAN TRUST

T.: +351 214 278 700
F.: +351 214 278 709
www.grupo-certilab.com
comercial@grupo-certilab.com

Tuttnauer
Your Sterilization & Infection Control Partners



D Line | Tabletop Autoclaves

Reliable & Robust

D-line Tabletop Autoclaves are designed for the needs of modern clinics where autoclaves are expected to operate non-stop every workday.

Designed for the sterilization processing needs of:

- **Medical Clinics**
- **Dental Clinics**
- **Veterinary Clinics**





Closed Door Drying

- Door remains closed during the drying stage to maintain sterility and ensure efficient drying (included with EA/EKA models). A high efficiency air pump circulates filtered air through the chamber for fast drying.

Self Locking Door

- Newly designed door is easy to open and close **with one hand**
- Self locking with double safety locking mechanism

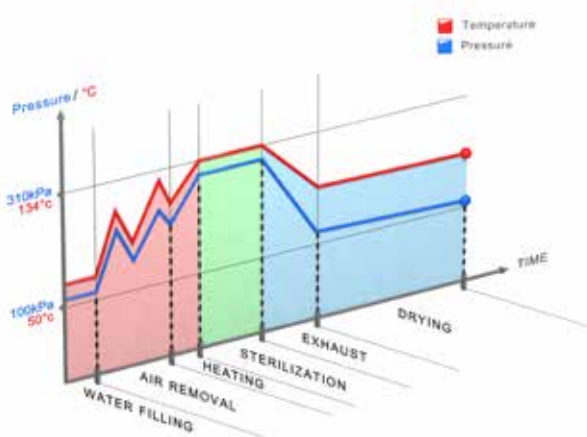

Convenient Front Water Filling

- Accessible **front or top** water filling
- Front water filling allows you to use the space above the autoclave



Dynamic Pulsed Air Removal

- Removes air from the chamber using pulsed steam resulting in uniform temperature distribution



Top Quality Stainless Steel

- Durable 316L stainless steel electro-polished chamber lasts longer than competitor 304 stainless steel chambers
- Stainless steel door with mirror polish surface is highly resistant to corrosion



Safety Features

- Cycle will not start if the door is open or not properly locked
- An automated double locking safety device prevents the door from opening while the chamber is pressurized
- Safety locking device prevents door from opening until chamber pressure reaches atmospheric pressure

Control Panel

Innovative Multi-Color Display

A bright LCD panel for easy reading, with multilingual interface (26 languages).

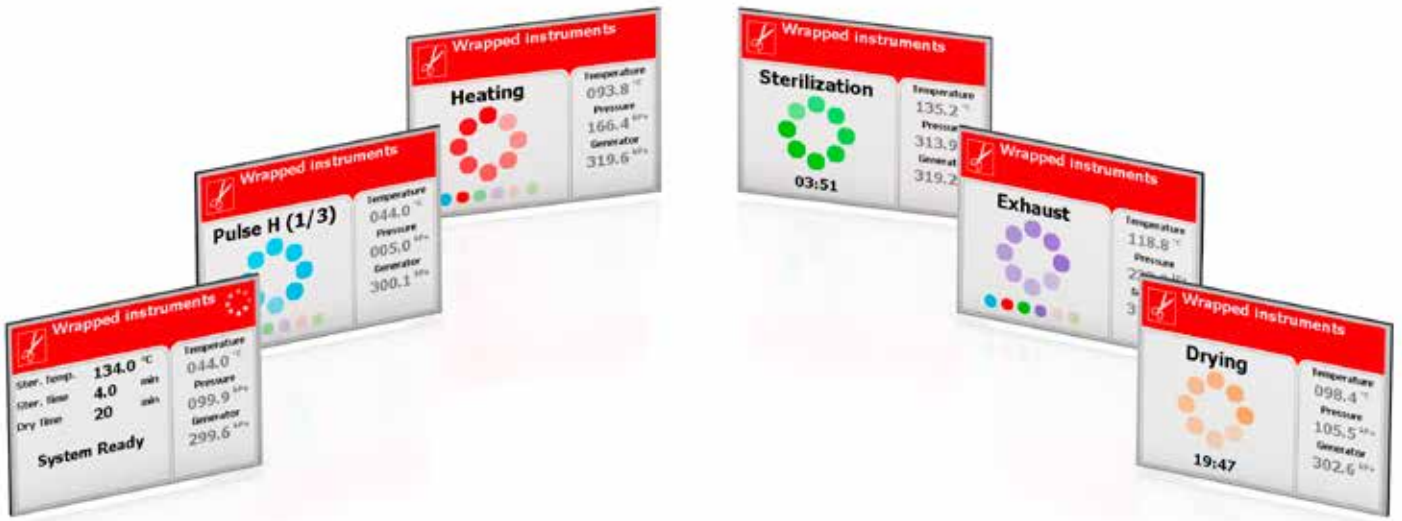

Cycle Parameters

Parameter settings for temperature, sterilization time and drying time



Real-Time Measured Values

Shows real-time values for chamber temperature & pressure, and generator pressure

Easy Pad

A user-friendly 3 button keypad enables the user to browse with ease through the sterilization cycle program settings and user directories

Thermal Printer

Optional high quality built-in thermal printer for paper printouts.





Digital Cycle Data on Your PC

- Save cycle data files on your PC with no additional software or specialized hardware
- No need for printing and filing cycle print-outs



Connect USB memory



Select "Export History"



Connect USB memory to your PC

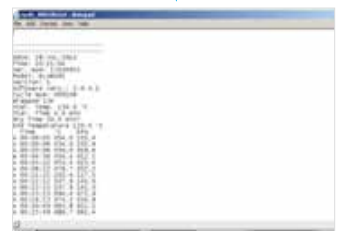

View cycle data files on your PC



Optional



Create reports with R.P.C.R

2340EK

2340EKA

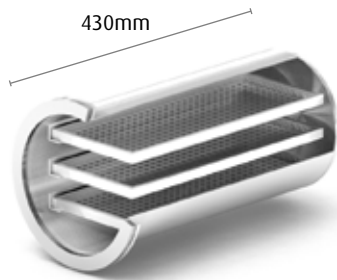

19.8 Liter Chamber

Class S

EKA Models provide closed door active drying

Class N

EK Models require door to be slightly open for drying

2840EK

2840EKA

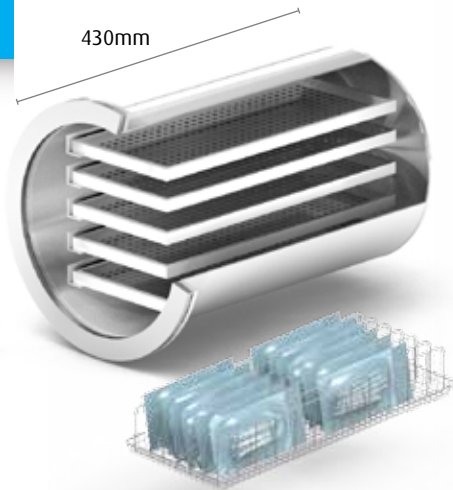

28.5 Liter Chamber

Free additional pouch rack

Technical Specification

Model	Chamber Volume	Chamber Size W x D (mm)	Standard Cassette Capacity	Tray Dimensions DxWxH (mm)	No. of Trays	Freq. (Hz)	Voltage(V) Power(W) Current (A)	EK/EKA-110 (optional)
2340EK	19.8 Liters	230x430	2 Full & 2 Half	415x170x20	3	50/60 Hz	230V 2200W 9.6A	110V 1400W 12A
2340EKA								
2840EK	28.5 Liters	280x430	4 Full & 4 Half	415x170x20	5	50/60 Hz		
2840EKA								

3850E

3850EA

65 Liter Chamber



Class S

EA Models provide closed door active drying

Class N

E Models require door to be slightly open for drying

3870E

3870EA

85 Liter Chamber

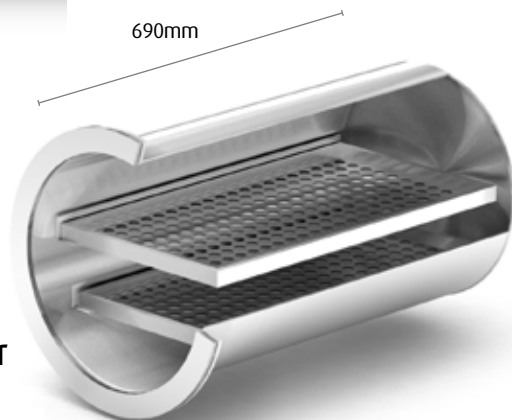

Technical Specification

Model	Chamber Volume	Chamber Size W x D (mm)	Standard Cassette Capacity	Tray Dimensions DxWxH (mm)	No. of Trays	Voltage (V) Freq. (Hz)	Power(W) Current (A)	External Dimension DxWxH (mm)
3850E	65 Liters	380x500	8 Full	495x286x25	2	230V 50/60Hz	2400W 11A	765x720x540
3850EA				495x350x25				
3870E	85 Liters	380x690	12 Full	665x275x25	2	230V 50/60Hz	3000W 13A	940x720x540
3870EA				665x340x25				

Sterilization Programs

Easy to operate with 4 pre-programmed sterilization programs and 20 customizable programs

Program	Load Type	Temp. (°C)	Sterilization Time (min)	Dry Time (min)	Cycle time (in min) without drying*			
					2340	2840	3850	3870
Unwrapped 134	Unwrapped instruments	134	3	1	17-20 min	25-28 min	30-33 min	30-33 min
Wrapped 134	Wrapped instruments	134	7	20	21-24 min	27-30 min	32-35 min	35-38 min
Unwrapped 121	Unwrapped delicate instruments	121	15	1	29-32 min	32-34 min	43-46 min	51-54 min
Wrapped 121	Wrapped delicate instruments	121	20	20	33-36 min	37-40 min	49-51 min	59-62 min

*Wrapped cycle load of 1.5 kg. Unwrapped cycle load of 3kg





Model	Front View	Side View
2340EK/EKA		
2840EK/EKA		
3850E/EA		
3870E/EA		

R.P.C.R Software

Automatic Recording of Cycle Information to Your PC

Reporting You Can Rely On

- Automatic recording of cycle information to any PC on your network
- Convenient access to graphs and tables that are easy to understand
- Easily generate PDF reports
- No need to file printouts, saving you time

Be in Control with Real-Time Remote Monitoring

- See the real-time autoclave display on your PC
- Monitor all activity for up to 8 autoclaves

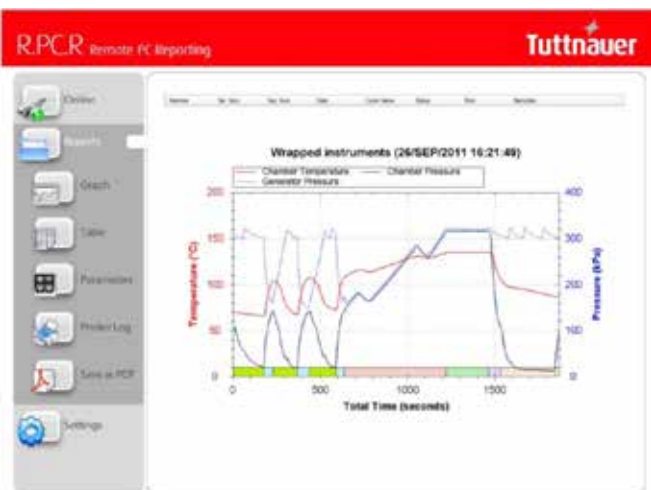

With R.P.C.R you can see:

Graphs of the cycle data, numeric cycle data, cycle print-outs, measured values table, table of parameters.

Standards and Directives

Partial list of standards and directives:

Pressure Vessel

All pressure vessels and boilers are certified according to ASME code section I and section VIII, Div. I and PED 97/23/EC - Pressure Equipment Directive

Quality Standards

- ISO 9001:2008 - Quality Management Systems
- EN ISO 13485:2012 Quality Management System – Medical Devices

Directives

- MDD 93/42/EEC amended in Directive 2007/47/EEC
- PED 97/23/EC - Pressure Equipment Directive
- 2002/96/EC WEEE and 2002/95/EC RoHS

Standards

- AAMI/ANIS ST-5, FDA 510K cleared
- EN 13060: 2004+A2: 2010 - Small Steam Sterilizer
- EN 61010-1: 2010 Safety Requirements for measurement control and laboratory use
- EN 61326-1: 2006 Electrical Equipment for EMC Requirements
- EN 61010-2-40: 2005 Safety requirements for sterilizers used to treat medical materials
- EN 17665-1: 2006 Sterilization of health care products – moist heat

Complementary Products

Sealing Machine

Ensures that sterilized instruments remain sealed after sterilization and maintain perfect sterility during their shelf-life.



Water Distiller

Use mineral-free water to protect your autoclave and instruments at a fraction of the cost of bottled distilled water.



Chamber Brite™

Chamber Brite effectively cleans and descales the chamber, the reservoir and copper tubing of any steam autoclave.



Experience Since 1925

As a family owned business Tuttnauer has manufactured products for over 90 years that have developed a reputation for their quality, high performance and reliability, sophisticated features, and ability to satisfy customer expectations. Tuttnauer's sterilization & infection control products are trusted at over 350,000 installations worldwide including Hospitals, Clinics and Laboratories.

Exceptional Support Worldwide

Tuttnauer's staff provides expert pre-sales and after-sales support services to satisfy customer expectations. Our teams are made up of multi-cultural people who are able to comfortably work with customers around the world. Tuttnauer provides in-depth face-to-face training in many locations around the world to ensure that Tuttnauer technicians and engineers are experts in their ability to support each customer's technical service needs.

At Tuttnauer we highly value customer feedback which contributes to the continuous improvement of our products and support services.



More from Tuttnauer:

Featuring additional Tuttnauer product's for laboratory and life science applications.



Elara Line
Class B Autoclave



HSG Line
for Medical Centers



T-Max Horizontal Autoclaves
for Hospital CSSD



Learn from our Experts
Join our blog www.tuttnauer.com/blog



D-Line | Tabletop Autoclaves

International Sales and Marketing
E-mail: info@tuttnauer.com
www.tuttnauer.com

Tuttnauer Europe b.v.
Hoeksteen 11, 4815 PR
P.O.B. 7191, 4800 GD Breda
The Netherlands
Tel: +31 (0) 765 423 510, Fax: +31 (0) 765 423 540
E-mail: info@tuttnauer.nl

Tuttnauer USA Co.
25 Power Drive,
Hauppauge, NY 11788
Tel: +800 624 5836, +631 737 4850 Fax: +631 737 0720
E-mail: info@tuttnauerUSA.com

Tuttnauer
Your Sterilization & Infection Control Partners

Distributed by:

SUPPLYLAB
GRUPO CERTILAB COMPANY
SOLUTIONS YOU CAN TRUST

T.: +351 214 278 700
F.: +351 214 278 709
www.grupo-certilab.com
comercial@grupo-certilab.com